

PCH Piano Hinge Parts Conveyor

The Model PCH parts conveyor with hinged steel belt is ideal for carrying hot, oily parts from punch presses, forging machines, etc., to drums, hoppers, or other operations. Configurations range from straight to "Z" type units.

- 5 Belt Widths
- Piano Hinge Belt
- Heavy-duty PCHS Type Adjustable Floor Supports Available



Overall Frame Width	Between Rail Width	Belt Width	"A"	"B"	"C"		"D"		Weights (Lbs.)	
					4'	6'	4'	6'	4'	6'
10 3/8"	5 7/8"	6"	24"	4'	58"	75"	103 5/8"	120 5/8"	658	754
			30"	or			115 5/8"	132 5/8"	711	807
			36"	6'			127 5/8"	144 5/8"	755	851
12 3/8"	7 7/8"	8"	24"	4'	58"	75"	103 5/8"	120 5/8"	682	782
			30"	or			115 5/8"	132 5/8"	735	835
			36"	6'			127 5/8"	144 5/8"	781	881
16 3/8"	11 7/8"	12"	24"	4'	58"	75"	103 5/8"	120 5/8"	735	84
			30"	or			115 5/8"	132 5/8"	802	911
			36"	6'			127 5/8"	144 5/8"	843	952
22 3/8"	17 7/8"	18"	24"	4'	58"	75"	103 5/8"	120 5/8"	834	961
			30"	or			115 5/8"	132 5/8"	900	1027
			36"	6'			127 5/8"	144 5/8"	957	1084
28 3/8"	23 7/8"	24"	24"	4'	58"	75"	103 5/8"	120 5/8"	972	1123
			30"	or			115 5/8"	132 5/8"	1050	1201
			36"	6'			127 5/8"	144 5/8"	1116	1267

All weights in catalog are conveyor weights only. Accessories, crating, etc., are not included.

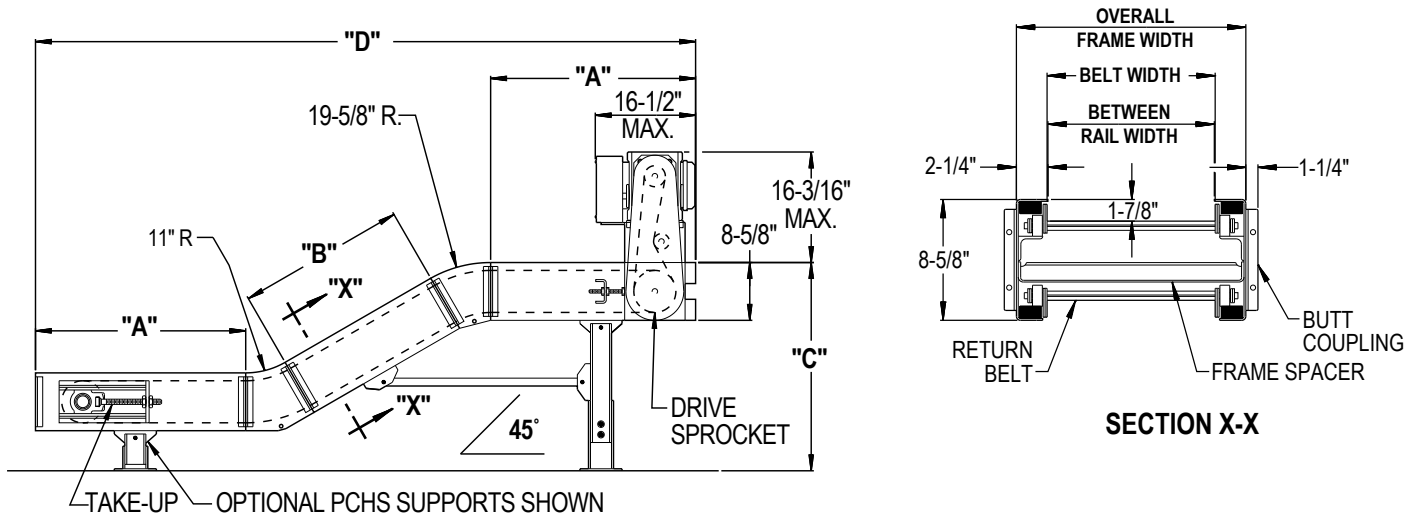

• STANDARD SPECIFICATIONS

OVERHEAD END DRIVE—Located on discharge end of conveyor. Chain guard located on right hand side.

BELT—Piano Hinge metal belt with 12 ga. plain bottom aprons. 2 ½ in. pitch chain with 1 ½ in. dia. hardened rollers with ¾ in. dia. hinge axle. 1 ½ in. high x 10 ga. continuous off-set side wing links.

BED—8 ¾ in. deep x 10 ga. powder painted, formed steel channel. Modular bed sections bolt together with butt couplings. 45° standard incline section.

BELT GUIDES—Steel angle mounted inside bed for tracking belt.

DRIVE SPROCKETS—5 in. pitch dia. with 1 7/8 in. dia. shaft, 6 tooth.

TAKE-UP SPROCKETS—5 in. pitch dia. with 1 7/8 in. dia. shaft, 6 tooth.

TAKE-UP—Take-ups are provided to insure proper belt tension.

BEARINGS—Sealed, re-lube bearings at drive and take-up.

SPEED REDUCTION— Sealed worm gear speed reducer driven by V-belt. No. 60 roller chain to drive sprockets.

MOTOR— 1 HP -208/230/460/575V-3 Ph. 60 Hz with torque limiter (Not a warranty item). Totally Enclosed.

BELT SPEED—Constant 30 FPM.

CAPACITY—35 lbs. belt capacity per linear foot of conveyor.

FLOOR SUPPORTS—Now supplied as optional equipment.



Model PCH design makes it ideal for positioning into or under punch presses and similar equipment. Horizontal discharge section allows easy positioning of hopper or drum for parts collection.



Metal Piano Hinge belt provides continuous reliable service. Construction is heavy-duty with perforated apron plates and solid steel, heat-treated rollers.

• OPTIONAL EQUIPMENT

FLOOR SUPPORTS—PCHS Type floor supports are available with a wide range of adjustment. Specify top of belt or roller elevation. One support required at every bed joint and ends of conveyor. Holes in feet for lagging to floor. Knee braces recommended above PCHS-3 support.

BELT—Perforated, pimpled, or pimpled and perforated. 1 ½ in. or 2 in. high cleats. Contact factory.

DRIP PANS—Mounted underneath conveyor frame for drainage.

COVER—Mounted on top of conveyor frame to keep parts from falling back when conveyor is used at steep incline.

INCLINES—30°, 45°, and 60° angles. Horizontal available.

BED—2 ft. through 10 ft. intermediate beds available.

MOTORS—Energy efficient, single phase, brakemotor, other characteristics. 2 HP maximum.

ELECTRICAL CONTROLS—Magnetic starters, push button stations and AC variable frequency drive.

BELT SPEED—Other constant and variable speeds.